

# How to Select the Proper Caster & Wheel

There is no simple formula or rule that can be followed in selecting the proper casters. Many varying and individual factors must be balanced to make the selection that will do the best job for you. The following are several of the more important considerations.

**Load Weight.** The heavier the load, the larger the wheel required for the caster. The weight of the load also influences the mobility of the wheel. Roller or ball bearings are recommended for loads over 400 pounds. Weight capacities are shown for each caster in this catalog.

**Floor Conditions.** Make sure the wheel you select is large enough to pass over cracks in the floor, tracks, moldings and other obstructions. For floor protection on linoleum, tile, carpet, etc., use polyurethane or Performa rubber wheels.

**Unusual Conditions.** Each wheel material has certain characteristics which will give the best results where unusual conditions exist. For example, where acids, oils, chemicals and other conditions harmful to rubber are present, Colson polyurethane, polyolefin, Maxim, phenolic or steel wheels are recommended. Check conditions, then select the caster and wheel.

**Rolling Ease.** The larger the wheel diameter, the easier it rolls. To maximize ergonomics and rolling ease, use Precision Ball Bearings where available. When possible, use the largest ball bearing wheel for best results.

**Extreme Climates.** Room temperatures are no problem for most casters, but extreme cold or heat can be a problem. Colson helps solve this problem with "Colson 45"—the green lube which assures caster rolling ease from 45°F below zero to 260°F above. It's standard on most Colson casters. (**Note:** Some wheel types should not be used in extreme temperature ranges. Consult factory.)

**Your Local Distributor.** Colson casters are available from stocking distributors across the U.S., Canada, & Mexico. Each is a caster specialist who can help you select the proper caster to suit your needs. Visit our website ([www.colsoncaster.com](http://www.colsoncaster.com)), or contact us for details at 1-800-643-5515.

## Caster Terms



## Wheel Terms

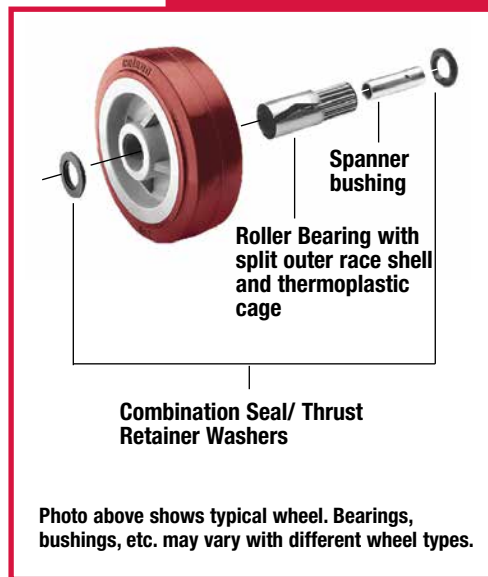

Photo above shows typical wheel. Bearings, bushings, etc. may vary with different wheel types.

## Caster Combinations for Trucks

In building, repairing and refurbishing mobile equipment, various effective caster combinations may be used. Several types of mountings are illustrated below.

### Three Swivel.

For barrel dollies and small portable machines. Affords excellent maneuverability. Be sure to select casters designed to take the weight load on three casters rather than the usual four.

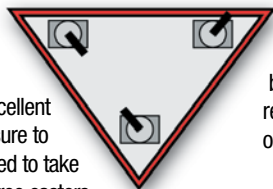

**Tilt Mounting.** A tilt mounting is the most economical, but should be limited to lighter loads.

The tilt is best when the load wheels are 1/8" taller than the balance wheels. Not recommended for use on ramps.

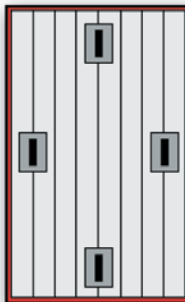

**Four Swivel.** Where a side motion is frequently needed, the four swivel arrangement is excellent. If the casters are equipped with swivel locks, this mounting is also practical for long straight travel as well as use on ramps. A most versatile arrangement.

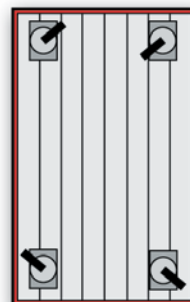

### Two Rigid, Two Swivel.

Most practical and inexpensive arrangement for straight and/or long distances. Can be used for heavy or medium loads, depending upon the weight capacity of the casters selected.

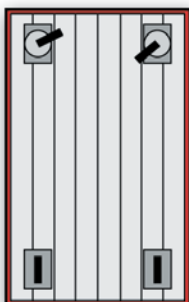

### Diamond Mounting.

Two rigid and two swivel casters, but the diamond shaped mounting greatly increases maneuverability. This mounting is not recommended for ramps.

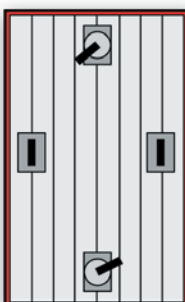

### Four Swivel, Two Rigid.

This is a level mounting design for heavy loads and long trucks. The two rigid casters help to distribute and reduce the load on the swivel units and thereby maintain good maneuverability and easy steering.

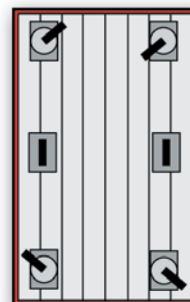

## Caster Model Number

### PREFIX

The prefix number shows the caster Series: 1 thru 8 Series with capacities ranging from 60 lbs to 6,000 lbs each.

### BODY

The body number shows the wheel diameter and type of fork mounting (swivel, rigid, stem).

### SUFFIX

The suffix number shows the type of wheel material and bearing.

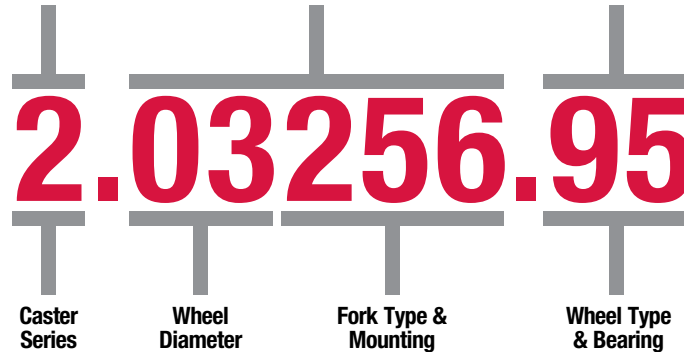

The above caster model number is a 2 Series caster with swivel top plate fork and polyurethane tread wheel (HI-TECH).

Note: The replacement fork model number is the same as above except the wheel suffix is not included (For example 2.03256).

## Wheel Model Number

### PREFIX

The prefix number shows the wheel Series: 1 thru 8 Series ranging from 60 lbs up to 7,200 lbs each.

### BODY

The body number shows the wheel diameter.

### SUFFIX

The suffix number shows the type of wheel material and bearing, and when applicable, the wheel tread width.

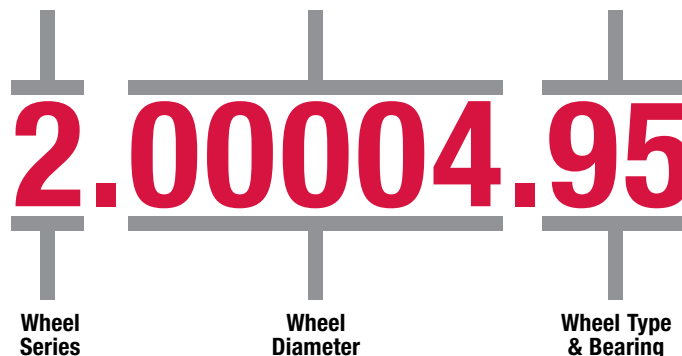

The above wheel model number is a 2 Series wheel with a diameter of 4", made with polyurethane tread and ball bearing.

Note: The diameter code is usually, but not always the diameter of the wheel (for example, the diameter code 3 could denote 3", 31/4" and 3 1/2" wheels). Please check wheel chart for actual diameter of wheel.

### IMPORTANT NOTICE • CAPACITY RATINGS

Caster and wheel capacities shown in this catalog are based on normal operating conditions as defined by the Institute of Caster and Wheel Manufacturers (ICWM). Normal operating conditions, as defined by the ICWM, consist of manual operations on a relatively smooth surface (such as concrete) with normal minor obstacles. All bearings must be properly lubricated. Conditions of excessive temperature and/or dirt will reduce ratings. **Do not exceed the capacity ratings published in this catalog.**

### CUSTOMER RESPONSIBILITIES

1. If caster stem is to be screwed into customer equipment, the customer must add a washer to the stem that will cover the incomplete threads and support the upper race.
2. The stem shoulder must fit tightly against the customer equipment.
3. It is the customer's responsibility to mount the caster in a workmanlike manner so there will be no risk to operator safety.
4. It is the customer's responsibility to determine the fitness of the caster for its application.



# Wheel Selection

## FLOOR SURFACES

### Wheel Selection Guide

WHEEL TYPE	CAPACITY (LBS EACH)	TEMPERATURE RANGE* (FAHRENHEIT)	FLOOR SURFACES										
			CARPET	BRICK	CONCRETE	LINOLEUM	ASPHALT	TERRAZZO	WOOD	SMOOTH STEEL	RIBBED STEEL	TILE	
Performa Rubber®	60 → 1700	-45° to +180° <sup>1</sup>	✓	✓	✓	✓	✓	✓	✓	✓	✓	✓	✓
Trans-forma®	400 → 600	-45° to +180° <sup>1</sup>	✓	✓	✓	✓	✓	✓	✓	✓	✓	✓	✓
Trans-forma® LT	400 → 500	-45° to +180° <sup>1</sup>	✓	✓	✓	✓	✓	✓	✓	✓	✓	✓	✓
Trans-forma® HD	600 → 900	-45° to +180° <sup>1</sup>	✓	✓	✓	✓	✓	✓	✓	✓	✓	✓	✓
Moldon Rubber	400 → 1140	-45° to +160°	✓	✓	✓	✓	✓	✓	✓	✓	✓	✓	✓
Triumph®	900 → 1200	-40° to +180°	✓	✓	✓	✓	✓	✓	✓	✓	✓	✓	✓
Conquest™	800 → 1500	-45° to +180°	✓	✓	✓	✓	✓	✓	✓	✓	✓	✓	✓
Moldon Polyurethane	700 → 3500	-45° to +180°	✓	✓	✓	✓	✓	✓	✓	✓	✓	✓	✓
Polyurethane HI-TECH®	100 → 1700	-45° to +180°	✓	✓	✓	✓	✓	✓	✓	✓	✓	✓	✓
Endura®	1000 → 1200	-45° to +230°	✓	✓	✓	✓	✓	✓	✓	✓	✓	✓	✓
Moldon Nylon	1000 → 1500	-45° to +180°	✓	✓	✓					✓	✓		
Commander HD	2160 → 7200	-30° to +220°	✓	✓	✓					✓	✓		
Maxim®	600 → 1400	-45° to +180°	✓	✓	✓	✓	✓	✓	✓	✓	✓	✓	✓
ThermoTECH®	250	-45° to +525° <sup>2</sup>	✓	✓	✓	✓	✓	✓	✓	✓	✓	✓	✓
Thermo®	300 → 1100	-70° to +525° <sup>3</sup>	✓	✓	✓					✓	✓		
Polyolefin	75 → 900	-45° to +180°	✓	✓	✓					✓	✓		
Phenolic	300 → 3500	-45° to +180°	✓	✓	✓				✓	✓			
Cast Iron	200 → 3000	-45° to +500°			✓					✓			
Forged Steel	1400 → 4500	-45° to +500°			✓					✓			
V-Groove	800 → 6000	-45° to +500°			✓					✓			

<sup>1</sup> 180° intermittent service; 120° continuous service  
<sup>2</sup> 525° intermittent service; 490° continuous service  
<sup>3</sup> 525° intermittent service; 480° continuous service

\*See Wheel Section (pages 64-95) for information regarding higher operating temperature ranges.

### Performa Chemical Chart

Substance	Rating	Substance	Rating	Substance	Rating	Substance	Rating
<b>Organics &amp; Solvents</b>		Methyl ethyl ketone	F	Acetic, 75%	G	<b>Alkalies</b>	
Acetone	G	Oakite (floor cleaner)	E	Acetic, glacial	G	Tartaric	F
Alcohol, butyl	G	Orange	X	Boric	G	Ammonium hydroxide	
Alcohol, ethyl	G	Naptha	F	Butyric	G	G	
Alcohol, methyl	G	Nitrobenzene	X	Chromic	F	Calcium hydroxide	G
Aniline	G	Phenol	X	Citric	G	Potassium hydroxide	G
Benzene	X	Toluene	X	Fluoboric	G	Sodium hydroxide	G
Bravo (wax stripper diluted)	E	Trichloroethylene	X	Hydrobromic, 25%	G	<b>Acids</b>	
Carbon disulfide	X	Varsol	X	Hydrochloric, 10%	G	Acid salts	G-F
Carbon tetrachloride	X	Vestalene (detergent diluted)	E	Hydrofluoric	F	Alkaline salts	G
Chlorobenzene	X	Urine	E	Lactic	F	Neutral salts	G
Chloroform	X	<b>Gases</b>		Nitric, 5%	G	Miscellaneous salts:	
Colson 45 lubricant	G	Carbon dioxide	G	Nitric, 65%	X	Potassium dichromate	G
Enclave SS-2 (parts cleaner)	X	Carbon monoxide	G	Oleic	G	Potassium permanganate	G
Ethyl acetate	F	Chlorine, wet	F	Oleum	X	Salt water	G
Ethylene chloride	G	Chlorine, dry	F	Oxalic	G	Sodium cyanide	G
Ethylene dichloride	F	Hydrogen sulfide	G	Phosphoric, 25%	G	Sodium ferricyanide	G
Ethyl ether	G	Sulfur dioxide, wet	F	Phosphoric, 85%	G	Sodium hypochlorite	G
Formaldehyde, 37%	G	Sulfur dioxide, dry	F	Sulfuric, 10%	G		
Gasoline	X	<b>Acids</b>		Sulfuric, 78%	F		
Heptane	X	Acetic, 10-50%	G	Tannic	G		
Methylene chloride	X						

E=Excellent G=Good F=Fair X=Unacceptable

#### IMPORTANT NOTICE • CHEMICAL RESISTANCE CHART GUIDELINES

This chart lists an extensive range of chemicals, solvents and gases. Examine the listings in this chart to determine if your application is considered compatible with Performa wheels. Ratings are at 72°F. Concentrations of aqueous solutions

are saturated except where noted. Information in this chart is based on laboratory tests and results may vary in actual caster applications. Field testing is recommended to confirm compatibility with your particular application. For information on the compatibility of other fluids and chemicals, please contact the factory.

OPERATING CONDITIONS

Wheel Selection Guide

WATER	STEAM	MILD CHEMICALS***	OIL & GREASE	METAL CHIPS	HIGH HEAT (+250°F)	EXTREME COLD (-45°F)	ANIMAL FATS	NOISE REDUCTION	FLOOR PROTECTION	CUSHION LOAD	DURO-METER RATINGS	CATALOG PAGE NUMBER	WHEEL TYPE
✓	✓	✓	✓	✓	✓	✓	✓	✓	✓	✓	65(±5)A	68-74	Performa® Rubber
✓	✓	✓	✓	✓	✓	✓	✓	✓	✓	✓	65(±5)A	75	Trans-forma®
✓	✓	✓	✓	✓	✓	✓	✓	✓	✓	✓	80(±5)A	75	Trans-forma® LT
✓	✓	✓	✓	✓	✓	✓	✓	✓	✓	✓	40(±5)D	76	Trans-forma® HD
✓	✓	✓	✓	✓	✓	✓	✓	✓	✓	✓	70(±5)A	77	Moldon Rubber
✓**	✓	✓	✓	✓	✓	✓	✓	✓	✓	✓	75 to 95(±5)A <sup>1</sup>	78	Triumph®
✓**	✓	✓	✓	✓	✓	✓	✓	✓	✓	✓	85(±5)A	78	Conquest™
✓**	✓	✓	✓	✓	✓	✓	✓	✓	✓	✓	45(±5)D	79 & 82	Moldon Polyurethane
✓**	✓	✓	✓	✓	✓	✓	✓	✓	✓	✓	55(±5)D	80-81	Polyurethane HI-TECH®
✓	✓	✓	✓	✓	✓	✓	✓	✓	✓	✓	63(±5)D	83	Endura®
✓	✓	✓	✓	✓	✓	✓	✓	✓	✓	✓	70(±5)D	84	Moldon Nylon
✓	✓	✓	✓	✓	✓	✓	✓	✓	✓	✓	80(±5)D	84	Commander HD
✓	✓	✓	✓	✓	✓	✓	✓	✓	✓	✓	85(±5)D	85	Maxim®
✓	✓	✓	✓	✓	✓	✓	✓	✓	✓	✓	75(±5)A	86	ThermoTECH®
✓	✓	✓	✓	✓	✓	✓	✓	✓	✓	✓	85(±5)D	87	Thermo®
✓	✓	✓	✓	✓	✓	✓	✓	✓	✓	✓	70(±5)D	88-89	Polyolefin
		✓	✓	✓	✓	✓	✓	✓	✓	✓	90(±5)D	90-91	Phenolic
		✓	✓	✓	✓	✓	✓	✓	✓	✓	-	92-93	Cast Iron®
		✓	✓	✓	✓	✓	✓	✓	✓	✓	-	94	Forged Steel
		✓	✓	✓	✓	✓	✓	✓	✓	✓	-	95	V-Groove

\*\*Intermittent contact at room temperature only. \*\*\*Consult factory for harsh chemicals.

<sup>1</sup> Red crowned tread: 75(±5) Shore A, Brown crowned tread 90(±5) Shore A, Red round tread: 89(±5) Shore A, Blue round tread 95(±5) Shore A.

The above chart is designed to provide the user with a general comparison of Colson wheel types under a variety of floor surfaces and operating conditions. For specific applications or unusual conditions, please consult factory.

Wheel Hardness Chart  
DUROMETER SCALES

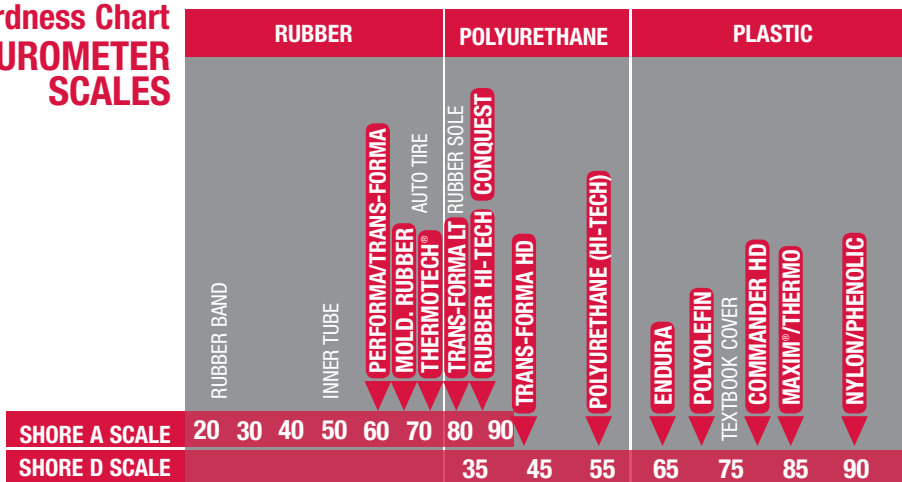

How To Select Wheel

