

ALBION[®]

the caster experts

INTRODUCING... *the ultimate TPE wheel for the outdoors*







- Innovative, new TPE alloy HYDROTECH™ wheels designed and formulated to withstand continuous exposure to moisture, significantly increasing life expectancy compared to TPU
- Fusion bonded to prevent tread separation and reduce noise related to mechanical interlock failures
- Same load capacity and rollability as TPU
- 40D (±5) durometer offers excellent abrasion resistance
- USA-made wheel built to last and backed with confidence (industry leading 3-year warranty)
- Since our founding in 1947, Albion has been known as “The Caster Experts” and is one of the most recognized and respected names in the material handling industry



HYDROTECH™

www.albioninc.com
Toll Free: 800.835.8911

Base Swivel Caster Number shown in Chart
For rigid models change "S" to "R" at end of base caster number.

Wheel Diameter (Inches) 
Tread Width (Inches) 
Capacity (lbs) (Rated for normal operation) 
Overall Height (Inches) 
Swivel Lead (Inches) 
Base Caster Number 

ALBION

the caster experts

ACCESSORIES

28 Series Kingpinless Maintenance Free Ergonomic Casters

HF	Wheel Diameter	Tread Width	Capacity	Overall Height	Swivel Lead	Base Caster Number
	6	2	900	7 1/2	2 1/2	28HF06229S
	8	2	1000	9 1/2	3 1/2	28HF08229S01
	8	2	1000	10 1/8	3 1/2	28HF08229S

Standard Bearing: Pedestal Precision Ball (29)
Optional Bearing: Roller (01); change 29 to 01



110 Kingpinless Casters

HF	Wheel Diameter	Tread Width	Capacity	Overall Height	Swivel Lead	Base Caster Number
	4	2	600	5 5/8	1 3/16	110HF04201S
	5	2	750	6 1/2	1 3/8	110HF05201S
	6	2	900	7 1/2	1 9/16	110HF06201S
	8	2	1000	9 1/2	2 1/4	110HF08201S01
	8	2	1000	10 1/8	2 1/4	110HF08201S

Standard Bearing: Roller Bearing (01)
Optional Bearing: Pedestal Precision Ball (01); change 01 to 29



120 Series Stainless Steel Kingpinless Casters

HF	Wheel Diameter	Tread Width	Capacity	Overall Height	Swivel Lead	Base Caster Number
	4	2	600	5 5/8	1 3/16	120HF04201S
	5	2	750	6 1/2	1 3/8	120HF05201S
	6	2	900	7 1/2	1 9/16	120HF06201S
	8	2	1000	9 1/2	2 1/4	120HF08201S01
	8	2	1000	10 1/8	2 1/4	120HF08201S

Standard Bearing: Roller Bearing (01)
Optional Bearing: Pedestal Precision Ball (01); change 01 to 29



18 Series Economical Kingpinless Maintenance Free Casters

HF	Wheel Diameter	Tread Width	Capacity	Overall Height	Swivel Lead	Base Caster Number
	4	2	600	5 5/8	1 11/16	18HF04229S
	5	2	750	6 1/2	1 5/8	18HF05229S
	6	2	900	7 1/2	1 3/4	18HF06229S
	8	2	1000	9 1/2	1 3/4	18HF08229S

Standard Bearing: Pedestal Precision Ball (29)
Optional Bearing: Roller (01); change 29 to 01



16 Series Standard Kingpin Casters

HF	Wheel Diameter	Tread Width	Capacity	Overall Height	Swivel Lead	Base Caster Number
	4	2	600	5 5/8	1 11/16	16HF04201S
	5	2	750	6 1/2	1 5/8	16HF05201S
	6	2	900	7 1/4	1 3/4	16HF06201S
	8	2	1000	9 1/2	1 3/4	16HF08201S

Standard Bearing: Roller Bearing (01)
Optional Bearing: Pedestal Precision Ball (29); change 01 to 29, Delrin (51); change 01 to 51



To order accessory, add code above to end of model. Example: 28HF06201SFBK

Standard Plate Size

Swivel and Rigid

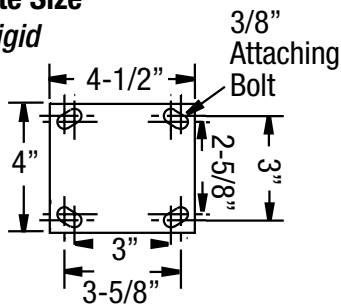

HYDROTECH™

The ultimate TPE wheel for the outdoors

REPLACEMENT WHEELS

Wheel Diameter (inches)	Tread Width (inches)	Capacity (Lbs) (based on normal operation)	Hub Length (inches)	Bore ID (inches)	Roller Bearing ID (inches)	Approx. Wt. (Lbs)	Wheel Bearing	Wheel Number
----------------------------	-------------------------	-----------------------------------------------	------------------------	---------------------	-------------------------------	----------------------	---------------	--------------

HydroTech Flat Tread (HF)

Standard Bearings

4	2	600	2-3/16	1-3/16	-	1	Plain Bore	WH4X2TPE19
	2	600	2-3/16	1-3/16	3/4	1	Delrin	HF0425112
	2	600	2-7/16	1-9/16	1/2	1	Pedestal Precision Ball	HF0422908
	2	600	2-3/16	1-3/16	3/4	1	Roller	HF0420212
5	2	750	2-3/16	1-3/16	-	1-1/8	Plain Bore	WH5X2TPE19
	2	750	2-3/16	1-3/16	3/4	1-1/8	Delrin	HF0525112
	2	750	2-7/16	1-9/16	1/2	1-1/8	Pedestal Precision Ball	HF0522908
	2	750	2-3/16	1-3/16	3/4	1-1/8	Roller	HF0520112
6	2	900	2-3/16	1-3/16	-	1-3/8	Plain Bore	WH6X2TPE19
	2	900	2-3/16	1-3/16	3/4	1-3/8	Delrin	HF0625112
	2	900	2-7/16	1-9/16	1/2	1-3/8	Pedestal Precision Ball	HF0622908
	2	900	2-3/16	1-3/16	3/4	1-3/8	Roller	HF0620112
8	2	1000	2-3/16	1-3/16	-	1-3/8	Plain Bore	WH8X2TPE19
	2	1000	2-3/16	1-3/16	3/4	1-3/8	Delrin	HF0825112
	2	1000	2-7/16	1-9/16	1/2	1-3/8	Pedestal Precision Ball	HF0822908
	2	1000	2-3/16	1-3/16	3/4	1-3/8	Roller	HF0820112



Temperature range:
-45°F to +180°F
(intermittent service)
+120°F (continuous
service)
Durometer:
40 ±(5) Shore D

Stainless Steel Bearings (Including Components)

4	2	600	2-3/16	1-3/16	-	1	Plain Bore	WH4X2TPE19
	2	600	2-3/16	1-3/16	3/4	1	Delrin	HF0425112SS
	2	600	2-7/16	1-9/16	1/2	1	Pedestal Precision Ball	HF0422908SS
	2	600	2-3/16	1-3/16	3/4	1	Roller	HF0420212SS
5	2	750	2-3/16	1-3/16	-	1-1/8	Plain Bore	WH5X2TPE19
	2	750	2-3/16	1-3/16	3/4	1-1/8	Delrin	HF0525112SS
	2	750	2-7/16	1-9/16	1/2	1-1/8	Pedestal Precision Ball	HF0522908SS
	2	750	2-3/16	1-3/16	3/4	1-1/8	Roller	HF0520112SS
6	2	900	2-3/16	1-3/16	-	1-3/8	Plain Bore	WH6X2TPE19
	2	900	2-3/16	1-3/16	3/4	1-3/8	Delrin	HF0625112SS
	2	900	2-7/16	1-9/16	1/2	1-3/8	Pedestal Precision Ball	HF0622908SS
	2	900	2-3/16	1-3/16	3/4	1-3/8	Roller	HF0620112SS
8	2	1000	2-3/16	1-3/16	-	1-3/8	Plain Bore	WH8X2TPE19
	2	1000	2-3/16	1-3/16	3/4	1-3/8	Delrin	HF0825112SS
	2	1000	2-7/16	1-9/16	1/2	1-3/8	Pedestal Precision Ball	HF0822908SS
	2	1000	2-3/16	1-3/16	3/4	1-3/8	Roller	HF0820112SS

HYDROTECH CHEMICAL CHART

Organics & Solvents

Acetone	G
Alcohol, butyl	G
Alcohol, ethyl	G
Alcohol, methyl	G
Aniline	G
Benzene	X
Bravo (wax stripper diluted)	E
Carbon disulfide	X
Carbon tetrachloride	X
Chlorobenzene	X
Chloroform	X
Colson 45 lubricant	G
Enclean SS-2 (parts cleaner)	X
Ethyl acetate	F
Ethylene chloride	G
Ethylene dichloride	F
Ethyl ether	G
Formaldehyde, 37%	G
Gasoline	X
Heptane	X

Methylene chloride	X
Methyl ethyl ketone	F
Oakite (floor cleaner)	E
Orangeve	X
Naptha	F
Nitrobenzene	X
Phenol	X
Toluene	X
Trichloroethylene	X
Varsol	X
Vestalene (detergent diluted)	E
Urine	E
Gases	
Carbon dioxide	G
Carbon monoxide	G
Chlorine, wet	F
Chlorine, dry	F
Hydrogen sulfide	G
Sulfur dioxide, wet	F
Sulfur dioxide, dry	F

Acids

Acetic, 10-50%	G
Acetic, 75%	G
Acetic, glacial	G
Boric	G
Butyric	G
Chromic	F
Citric	G
Fluoboric	G
Hydrobromic, 25%	G
Hydrochloric, 10%	G
Hydrofluoric	F
Lactic	F
Nitric, 5%	G
Nitric, 65%	X
Oleic	G
Oleum	X
Oxalic	G
Phosphoric, 25%	G
Phosphoric, 85%	G
Sulfuric, 10%	G

Sulfuric, 78%	F
Tannic	G
Alkalies	
Tartaric	F
Ammonium hydroxide	G
Calcium hydroxide	G
Potassium hydroxide	G
Sodium hydroxide	G
Salts	
Acid salts	G-F
Alkaline salts	G
Neutral salts	G
Miscellaneous salts:	
Potassium dichromate	G
Potassium permanganate	G
Salt water	G
Sodium cyanide	G
Sodium ferricyanide	G
Sodium hypochlorite	G

ALBION
the caster experts